

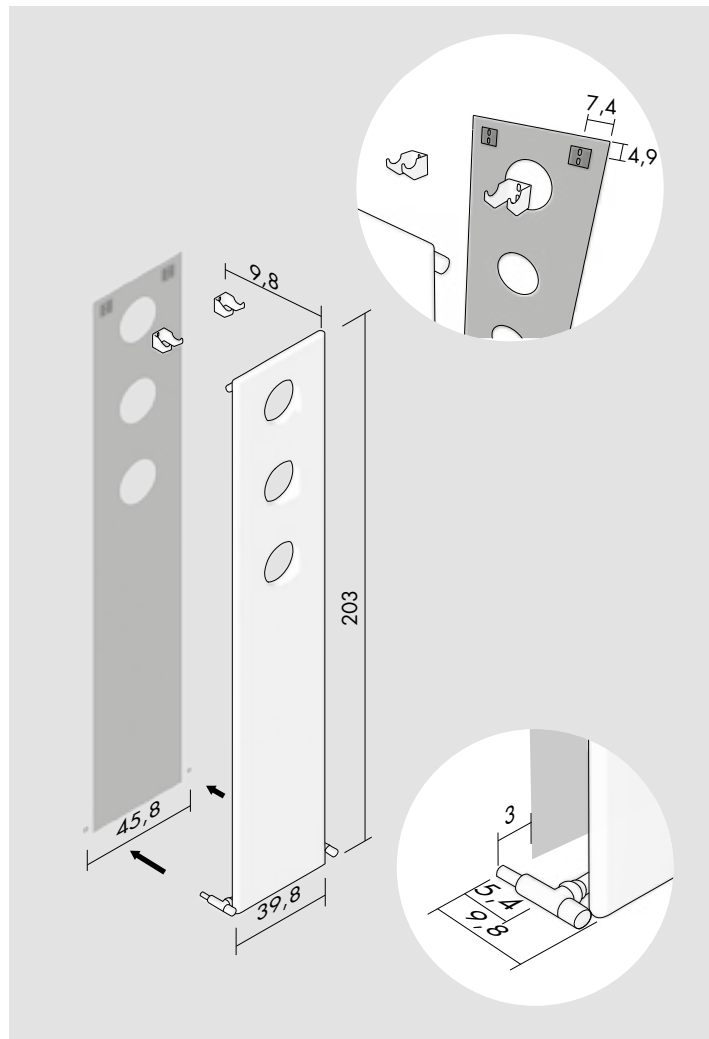

Kcal = Watt x 0.860
 BTU = Watt x 3.413

Watt Δt 60° = Watt Δt 50° x 1.264
 Watt Δt 40° = Watt Δt 50° x 0.750
 Watt Δt 30° = Watt Δt 50° x 0.518
 Watt Δt 20° = Watt Δt 50° x 0.307

p max = 10.0 bar



Treo V



| H cm | L cm | I* cm | I* cm | art* | Lt* | watt Δt 30° | watt Δt 50° |
|-------|------|-------|-------|-------------------|-----|---------------------|---------------------|
| 203.0 | 39.8 | 45.8 | 196.0 | TRVS203010 | 5.1 | 220 | 424 |

Standard connection / Raccord standard
 Standard Anschluss / Conexión estándar

[X]

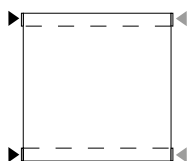

[XM_]

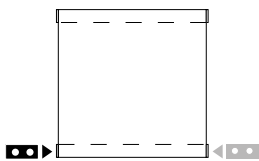

Special connection / Raccord spéciale / Speziell Anschluss / Conexión especial

[B]

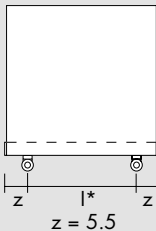

[E]

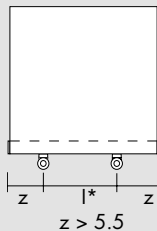

[S] Δ (P* 242)

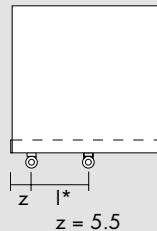

[D] Δ (P* 242)

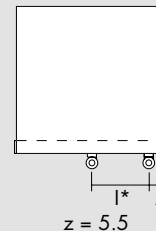

[PS] Δ (P* 242)

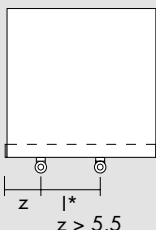

[PD] Δ (P* 242)

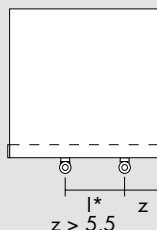

[5_] Δ (P* 242)

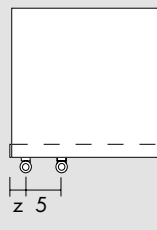

[5]

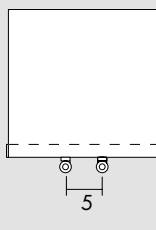

[P5_] Δ (P* 242)

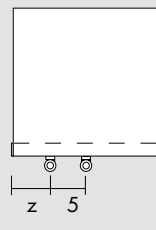

Replace _ with connection S (Left) or D (Right). / Remplacer le _ avec raccordement S (Gauche) ou D (Droite). /
 Um linker oder rechter Anschluss zu bestellen, bitte das Symbol _ mit S (links) oder D (rechts) ersetzen. /
 Sustituir el _ con las conexiones S (Izquierda) o D (Derecha).

art* = item / modèle / Artikel / artículo I* = pipe centres / distance entre depart et retour / Achsabstand / distancia entre las conexiones
 Lt* = water content for each element / volume d'eau pour chaque element / Wassergehalt für Element / contenido de agua por cada elemento

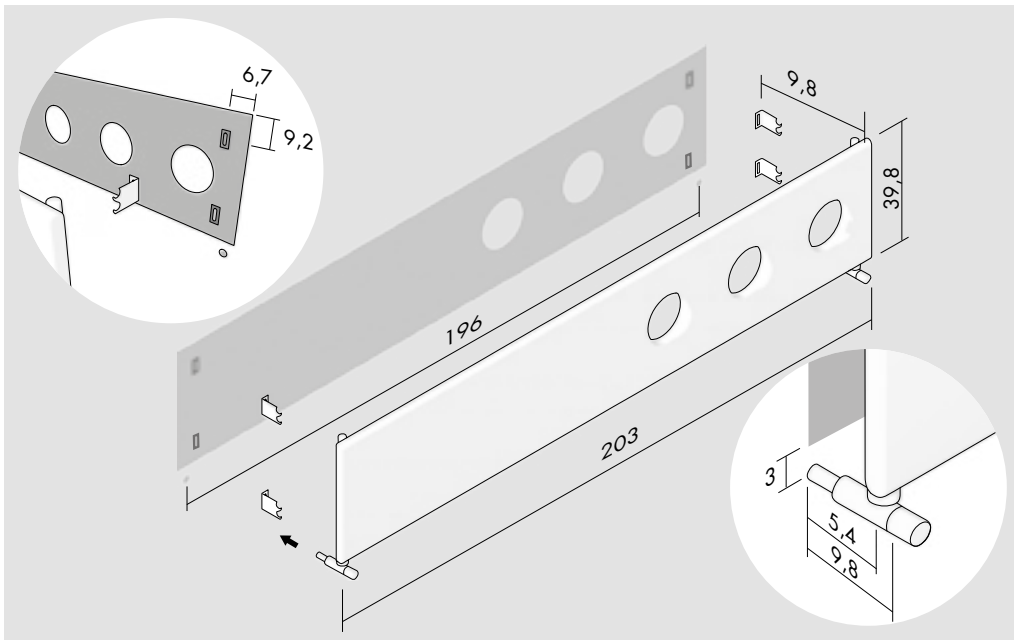

Kcal = Watt x 0.860
BTU = Watt x 3.413

Watt Δt 60° = Watt Δt 50° x 1.264
Watt Δt 40° = Watt Δt 50° x 0.750
Watt Δt 30° = Watt Δt 50° x 0.518
Watt Δt 20° = Watt Δt 50° x 0.307

p max = 10.0 bar

Treo O



| H cm | L cm | I* cm | I* cm | art* | Lt* | watt Δt 30° | watt Δt 50° |
|------|-------|-------|-------|--------------------|-----|-------------|-------------|
| 39.8 | 203.0 | 196.0 | 45.8 | TROS203010_ | 5.1 | 248 | 479 |

Standard connection / Raccord standard
Standard Anschluss / Conexión estándar

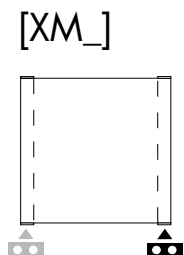
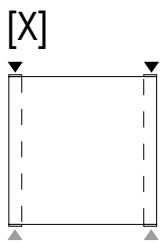

Special connection / Raccord spéciale / Speziell Anschluss / Conexión especial

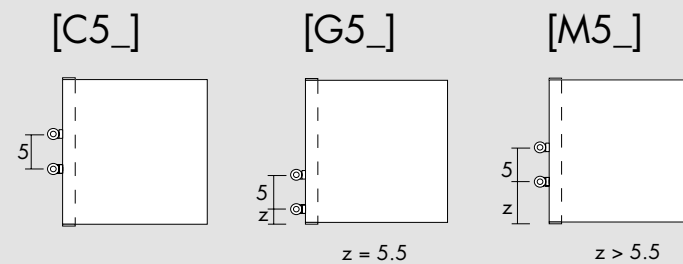
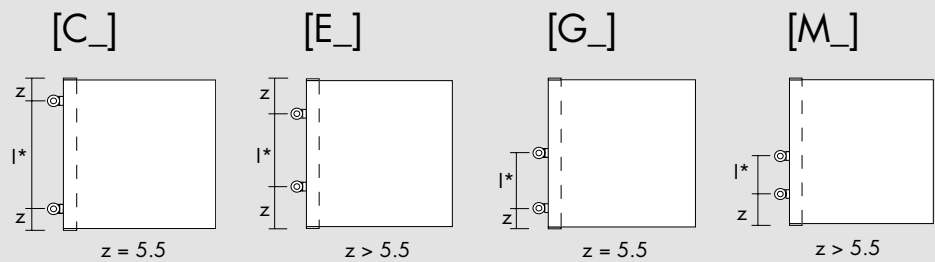

Replace _ with connection S (Left) or D (Right). / Remplacer le _ avec raccordement S (Gauche) ou D (Droite). /
Um linker oder rechter Anschluss zu bestellen, bitte das Symbol _ mit S (links) oder D (rechts) ersetzen. /
Sustituir el _ con las conexiones S (Izquierda) o D (Derecha).

Optional



Angled Valve
Vanne équerre
Eckausführung Ventil
Válvula a escuadra

[BIAN] **E12SQB**
[CROM] **E12SQR**



Thermostatic head
Tête thermostatique
Thermostatkopf
Cabezal termostático

[BIAN] **TTB**
[CROM] **TTR**

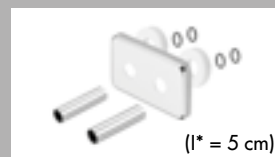

Sleeving kit
Kit couvre tuyau
Rosetten
Kit cubre tubo

[BIAN] **C5B**
[CROM] **C5R**

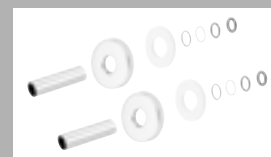

∅ ≤ 16 mm
[BIAN] **CTB**
[CROM] **CTR**

16 mm < ∅ < 24 mm
[BIAN] **CWB**
[CROM] **CWR**

art* = item / modèle / Artikel / artículo I* = pipe centres / distance entre depart et retour / Achsabstand / distancia entre las conexiones
Lt* = water content for each element / volume d'eau pour chaque element / Wassergehalt für Element / contenido de agua por cada elemento
P* = page / page / Seite / página